



TMJ YANG'S SYSTEM

Product Catalog of Customized
TMJ-Cranio-Jaw Prosthesis

PRODUCT CATALOG

Customized Total TMJ Prosthesis	01
Customized TMJ-Skull Base Combined Prosthesis	05
Customized Skull Base-Articular Fossa Prosthesis	09
Customized TMJ-Mandibular Combined Prosthesis	13
Standard Total TMJ Prosthesis	17

Customized Total TMJ Prosthesis

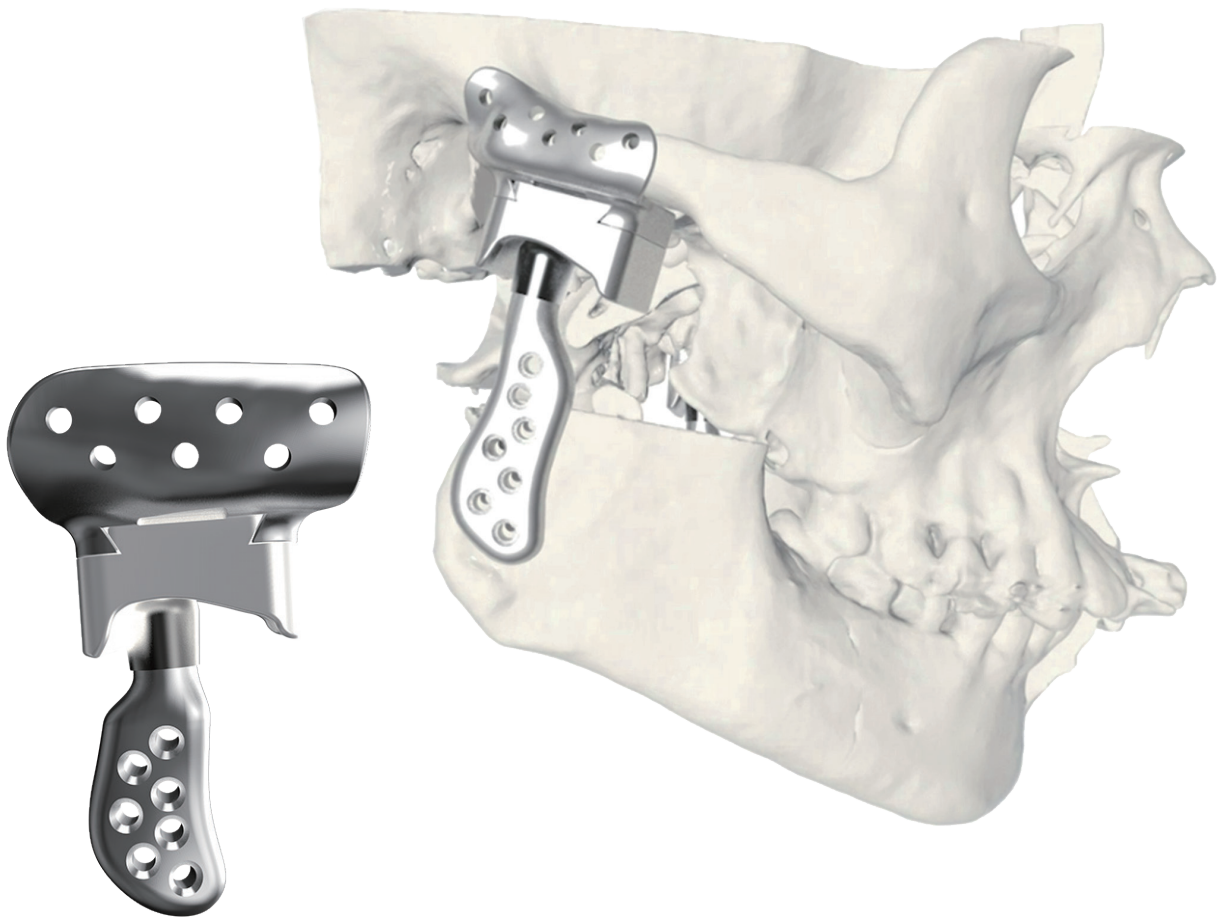

Classic Total TMJ Prosthesis

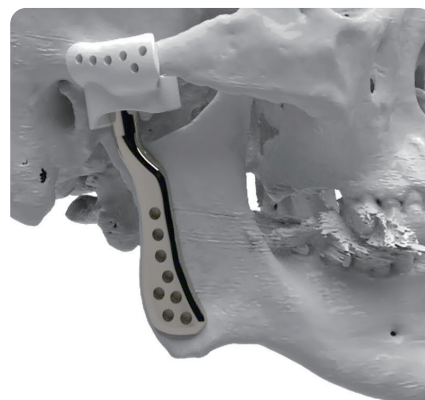
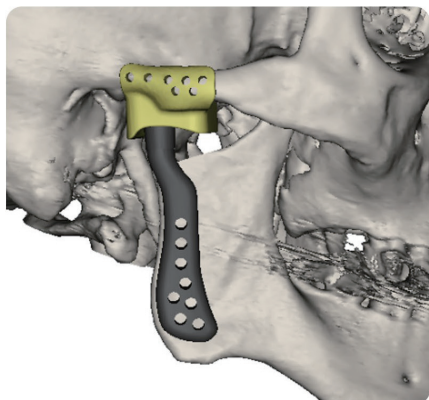

Total TMJ Prosthesis: Mandibular Positioning

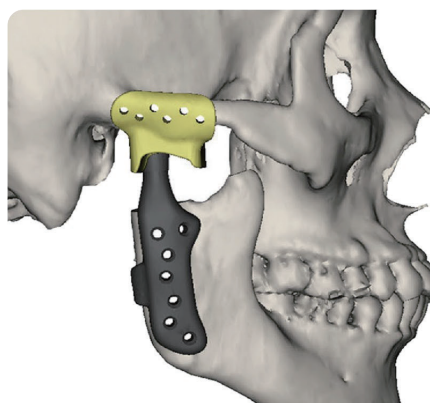

Total TMJ Prosthesis: Metal/Non-metal Fossa Prosthesis

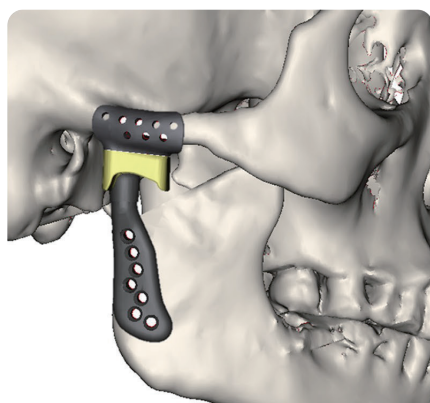

Preoperative Examination

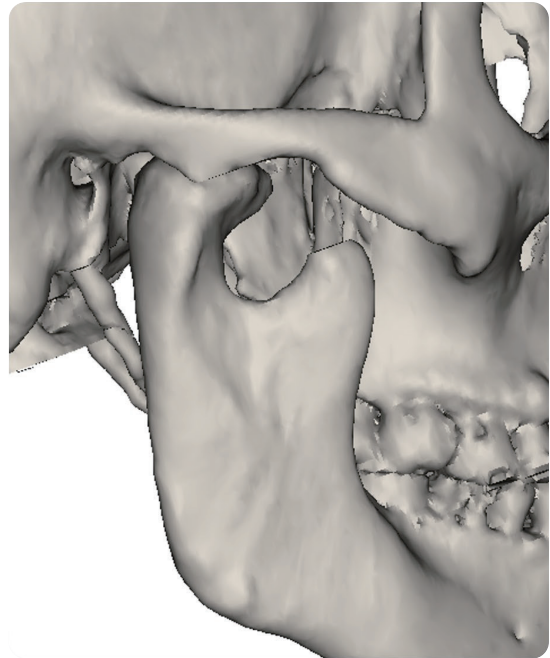
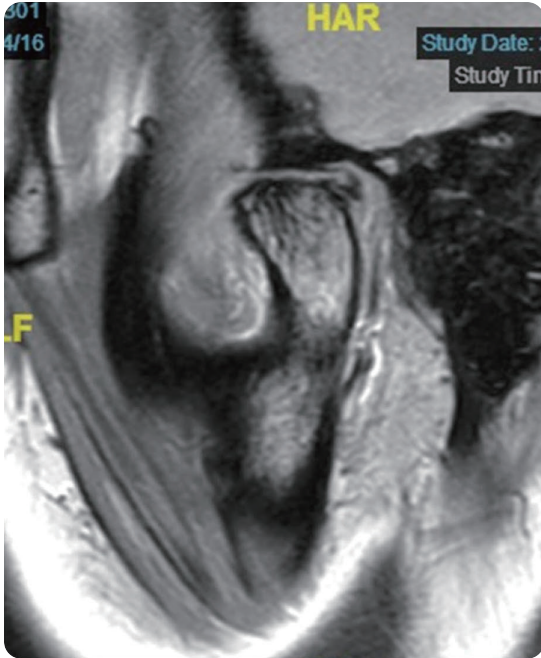

Surgical Planning

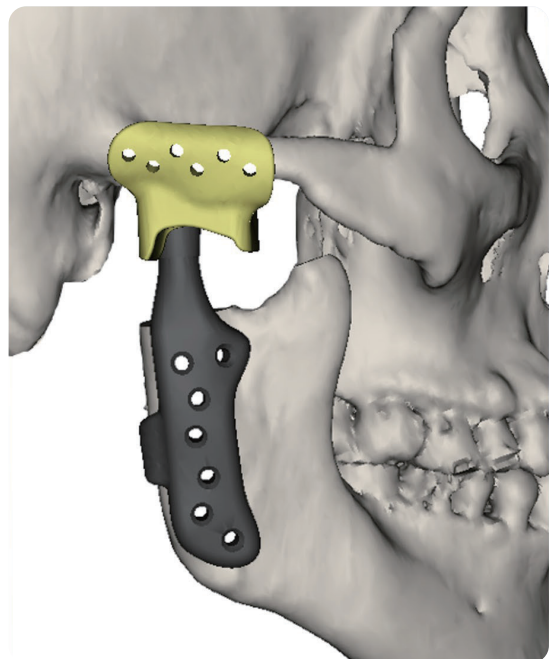
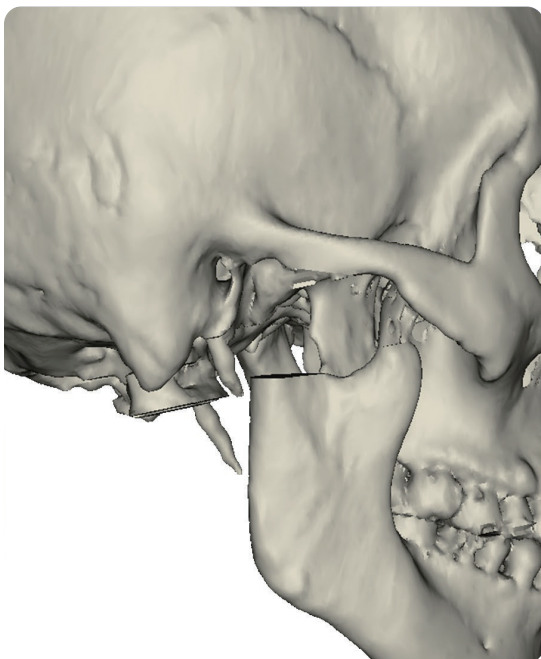

Surgical Procedure

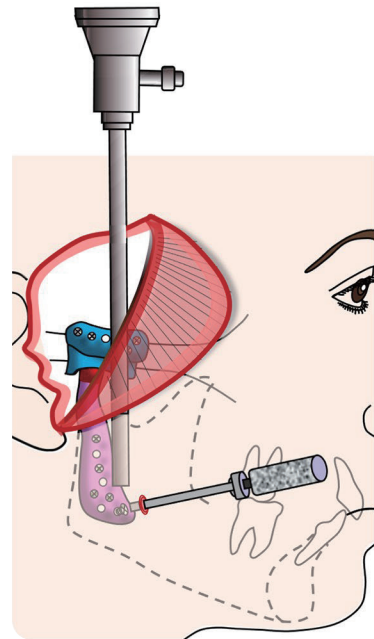
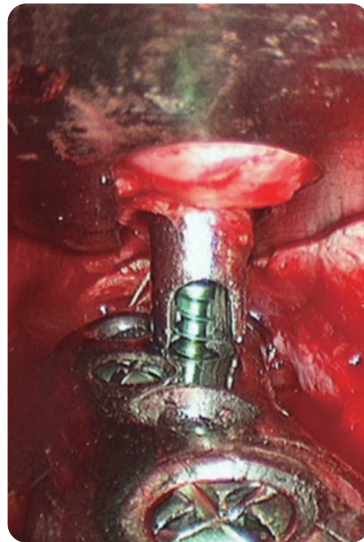
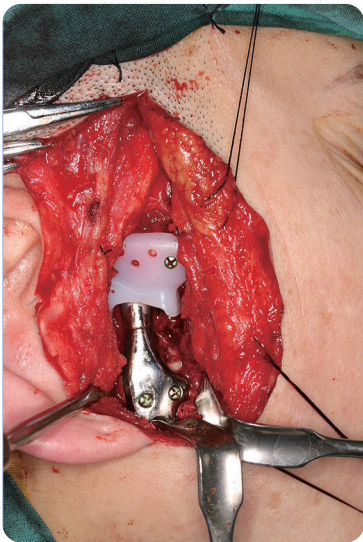

Surgical Outcome

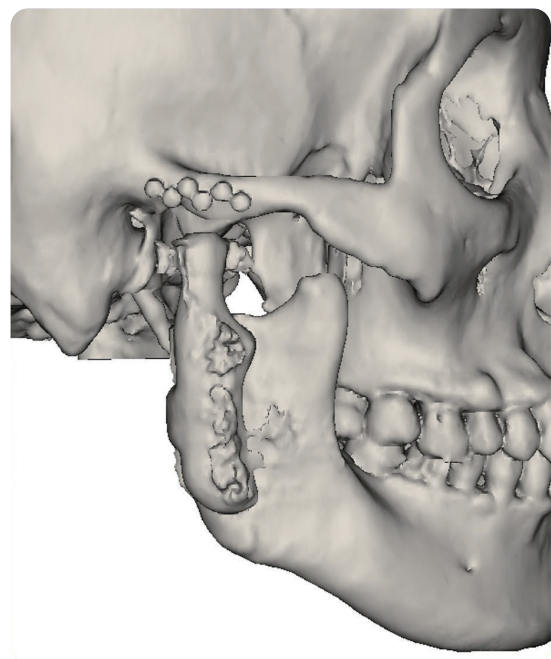
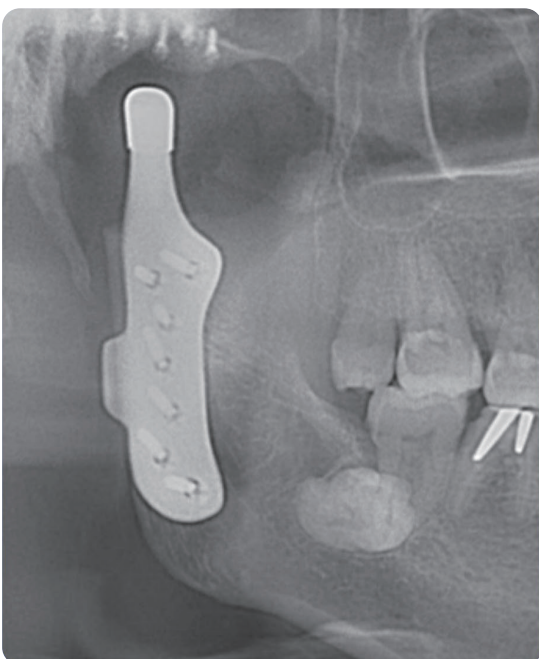

Customized TMJ-Skull Base Combined Prosthesis

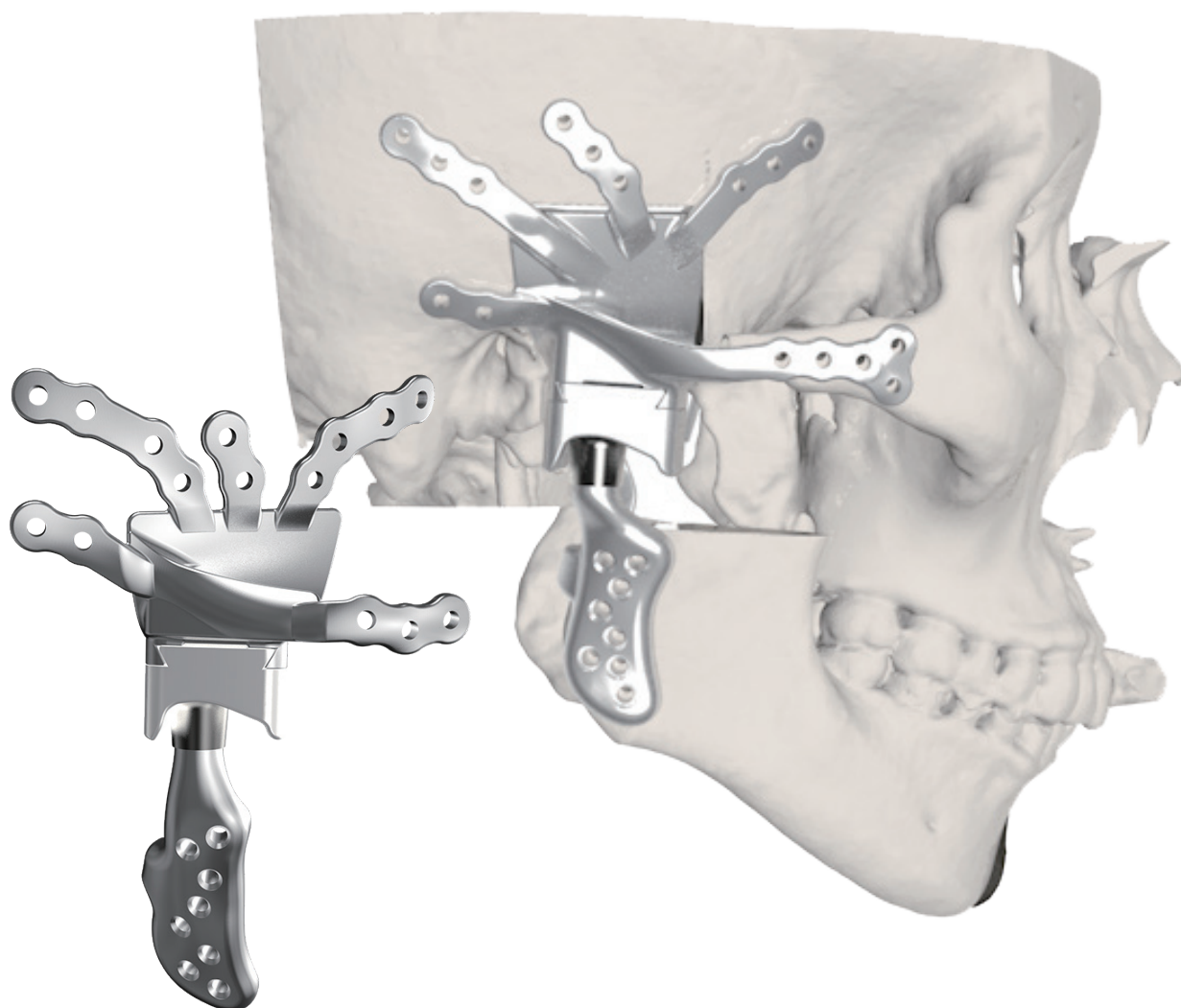

TMJ-Skull Base Combined Prosthesis: Peri-fixed

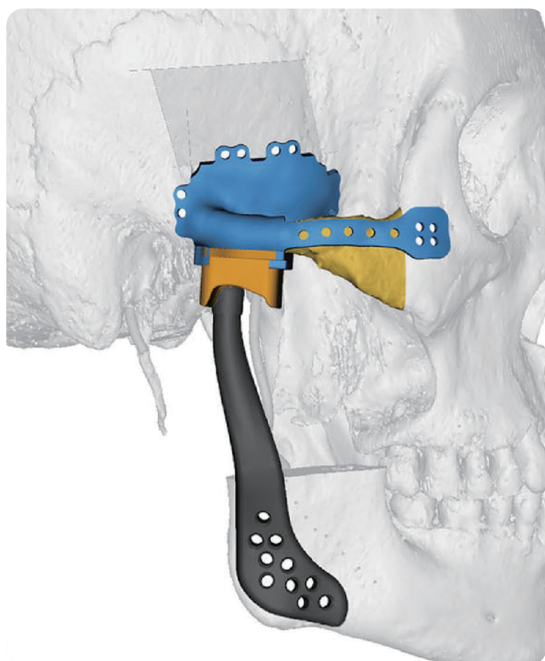

TMJ-Skull Base Combined Prosthesis: Fenestrated Bone Plate-fixed

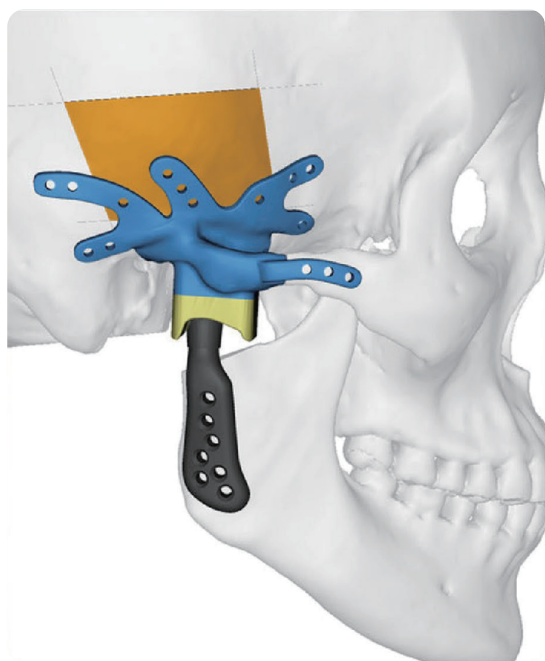

Preoperative Examination

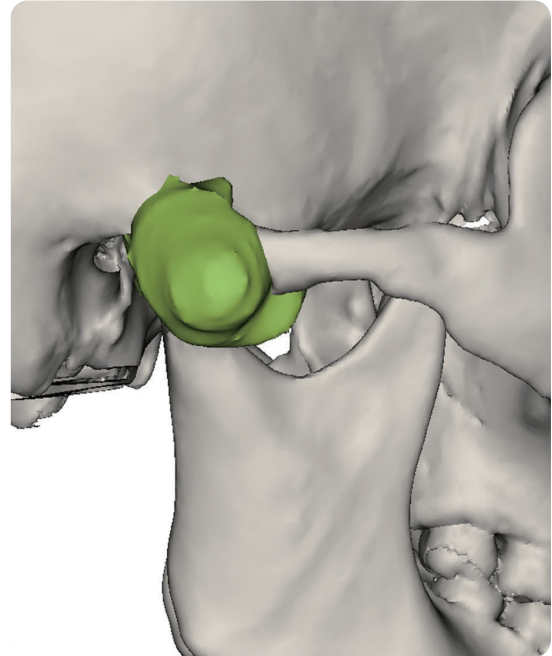
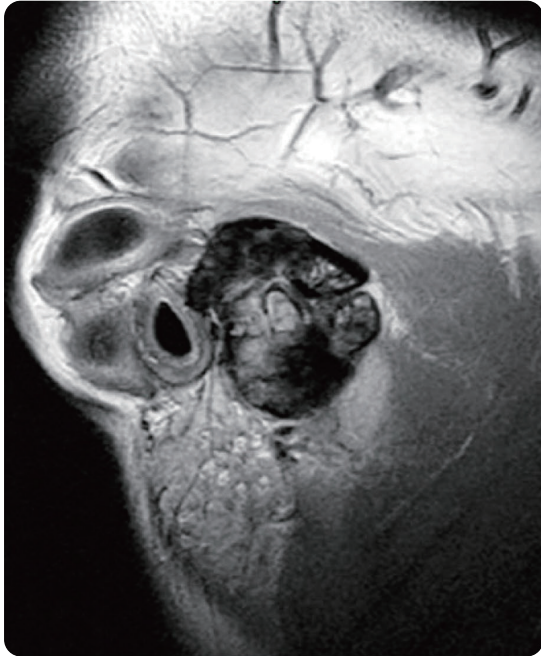

Surgical Planning

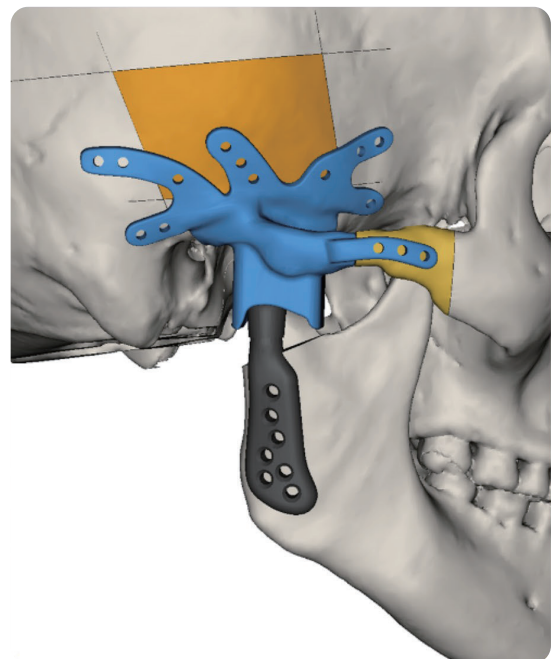
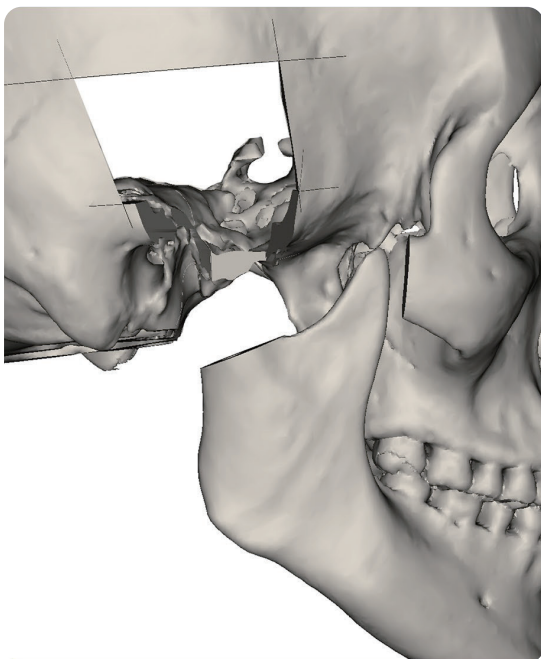

Surgical Procedure

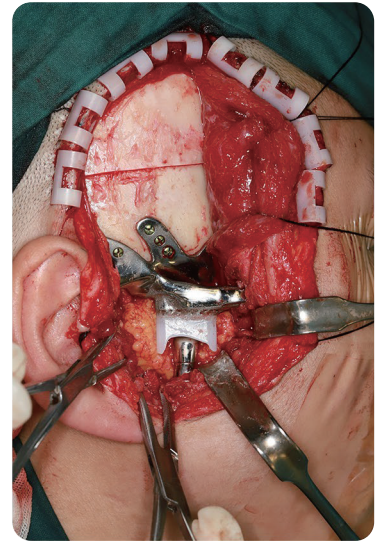
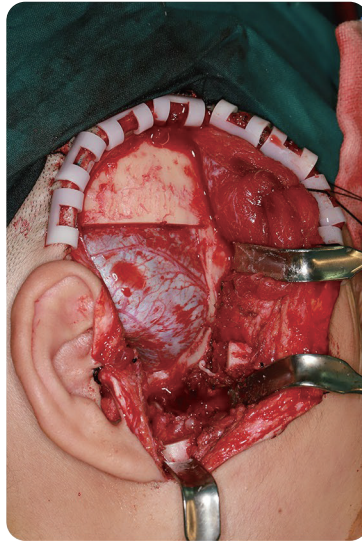
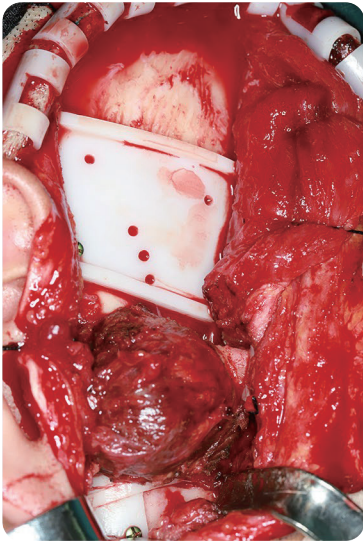

Surgical Outcome

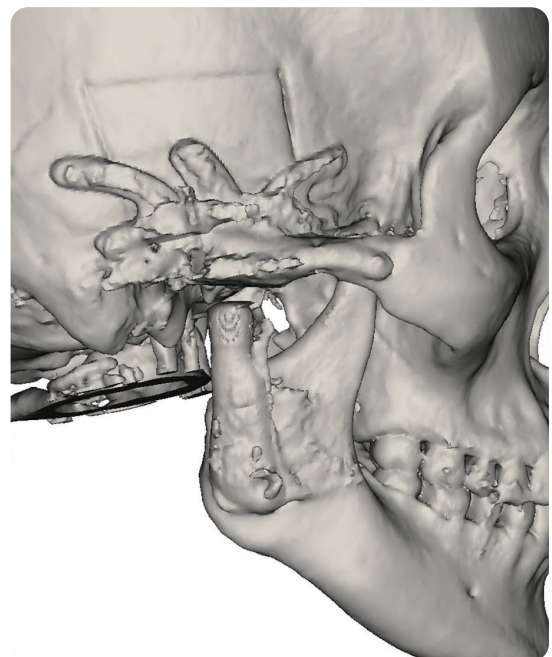
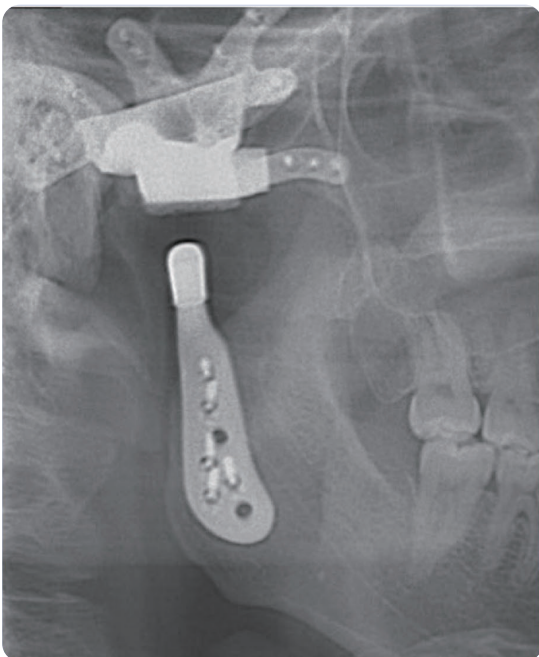

Customized Skull Base-Fossa Prosthesis



Skull Base-Fossa Prosthesis

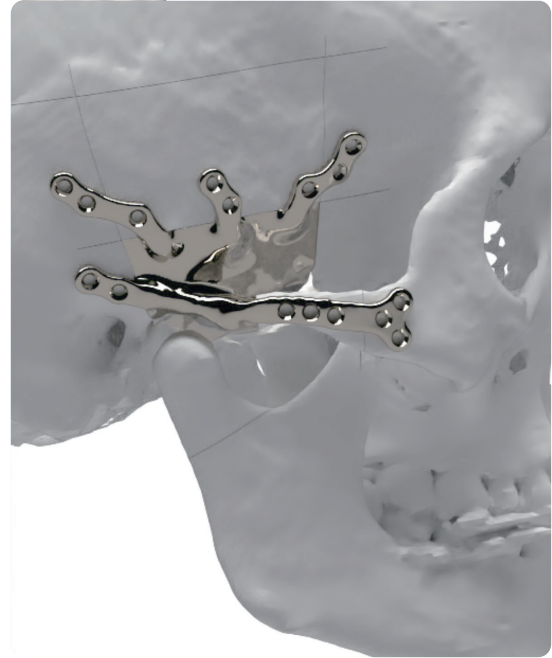
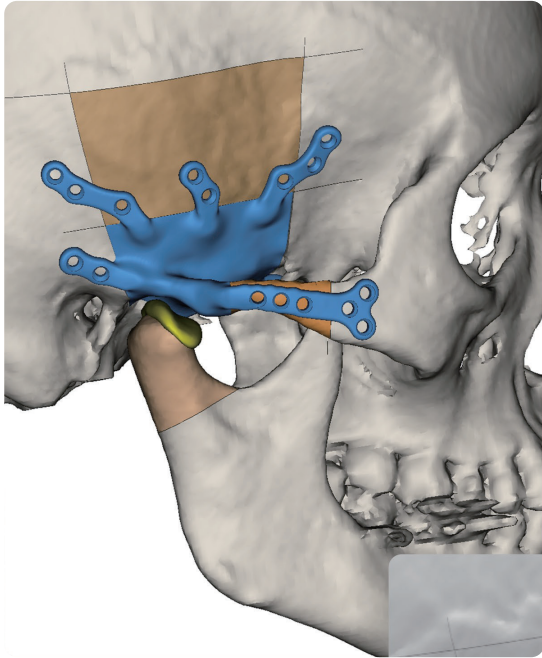

Preoperative Examination

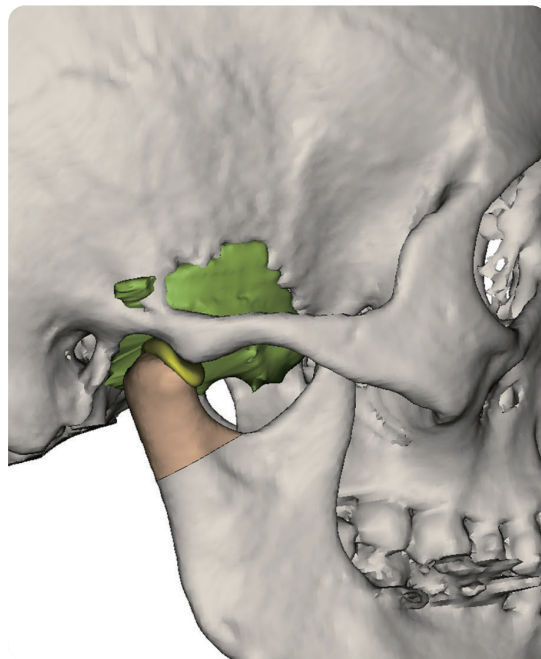
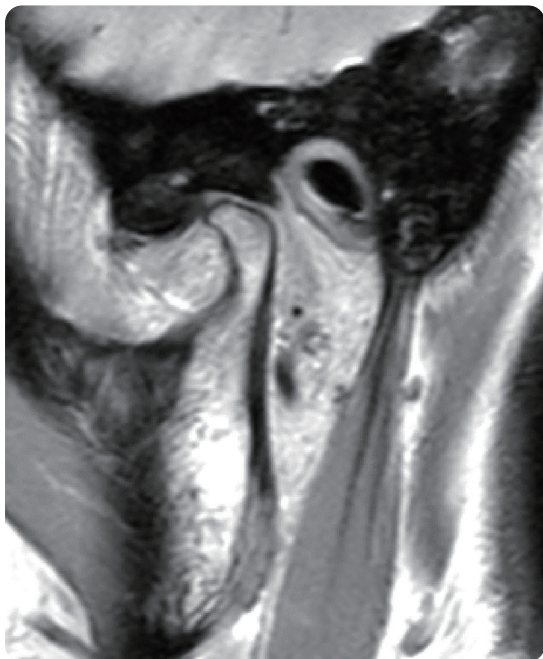

Surgical Planning

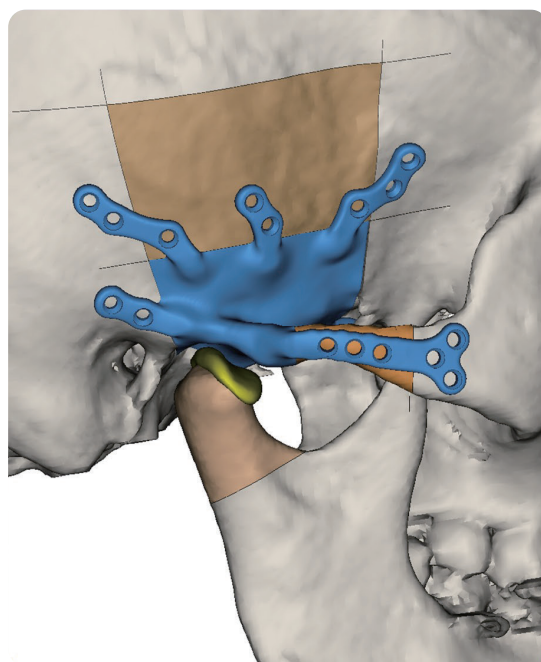
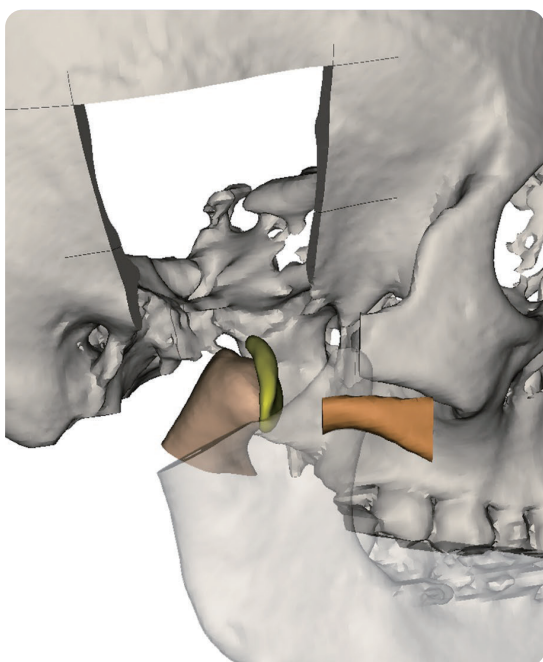

Surgical Procedure

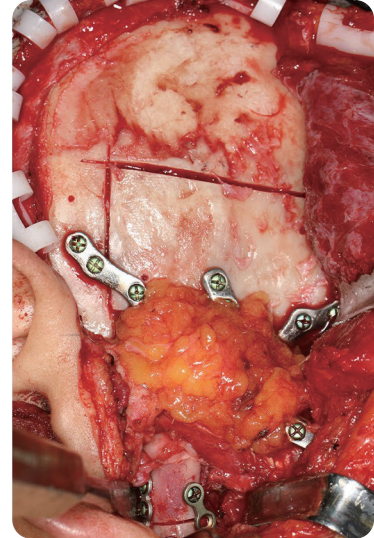
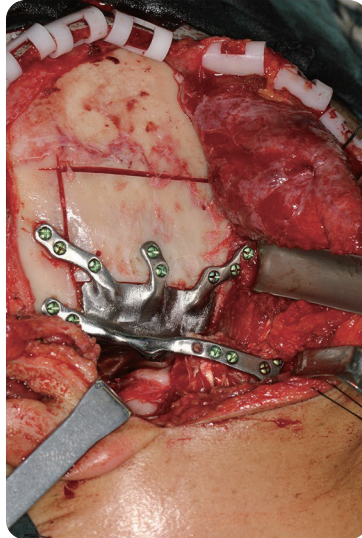
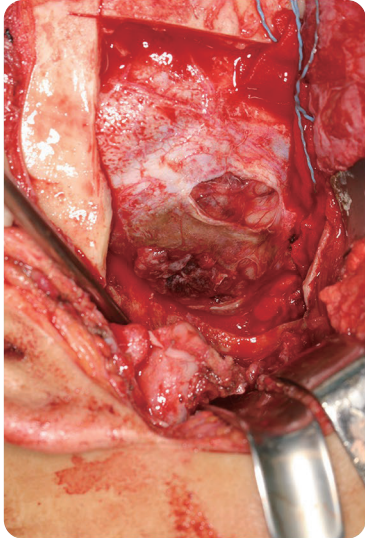

Surgical Outcome

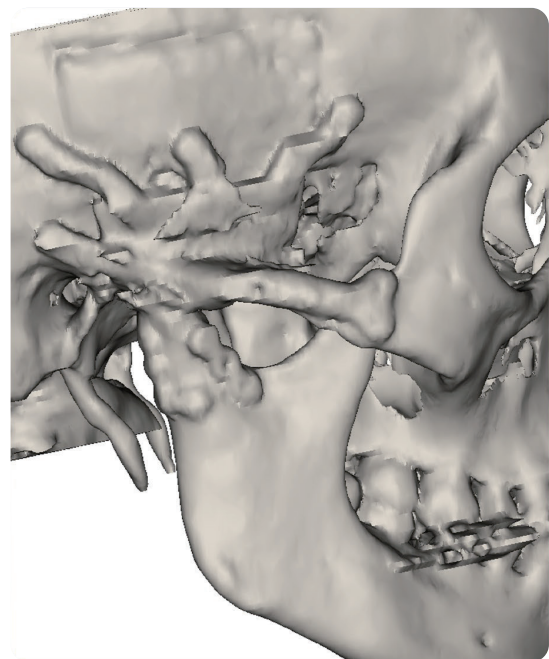

Customized TMJ-Mandibular Combined Prosthesis

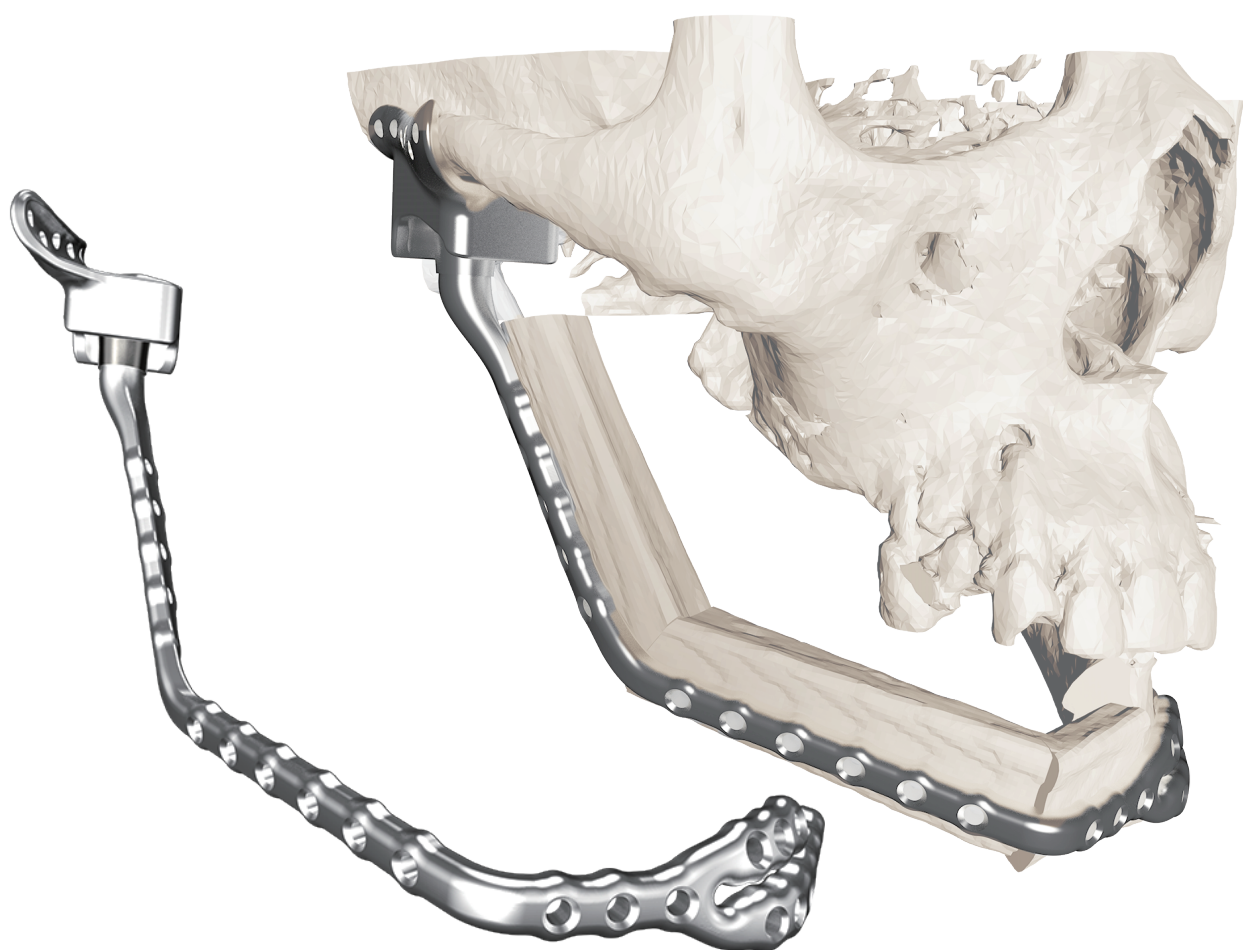

TMJ-Mandibular Combined Prosthesis: Wide-body

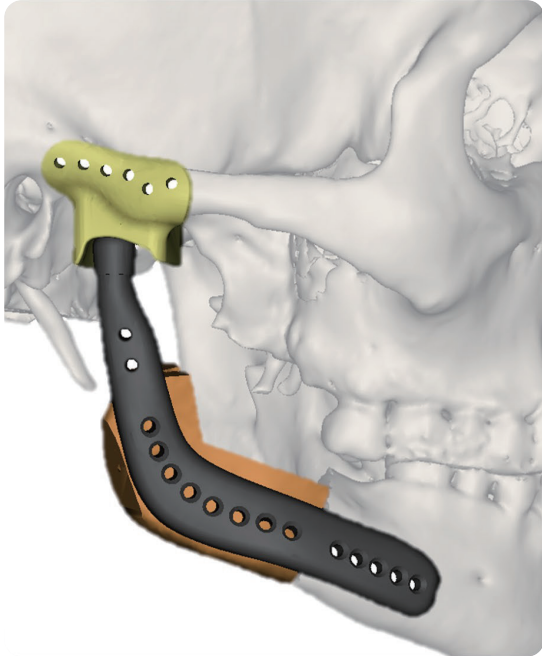

TMJ-Mandibular Combined Prosthesis:
Mandibular Body Augmentation

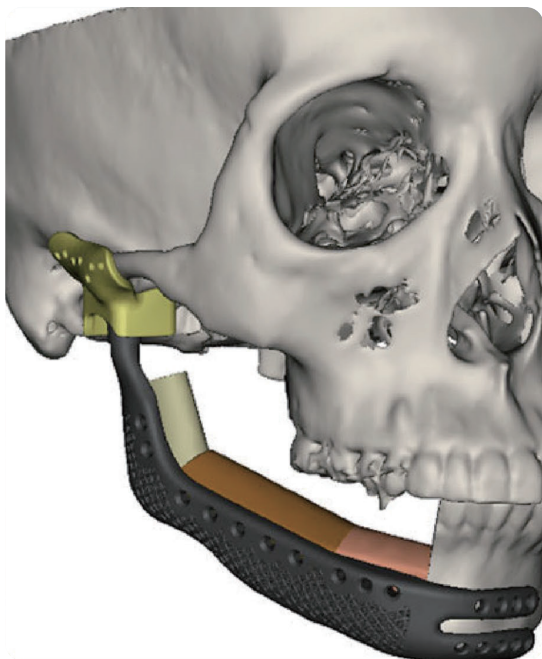

Preoperative Examination

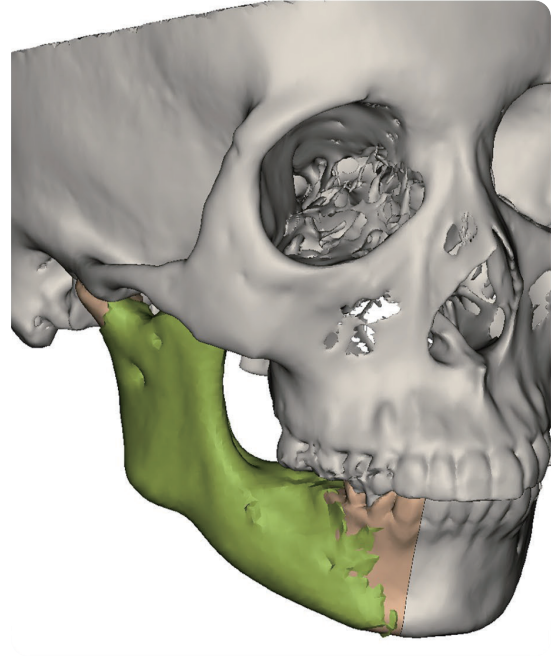
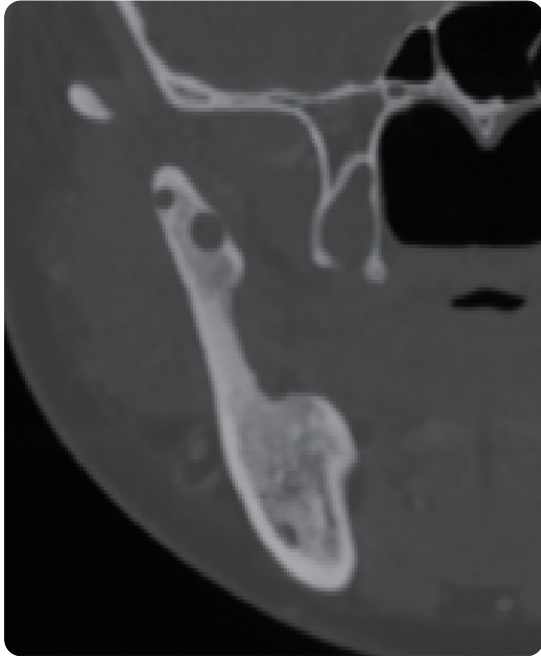

Surgical Planning

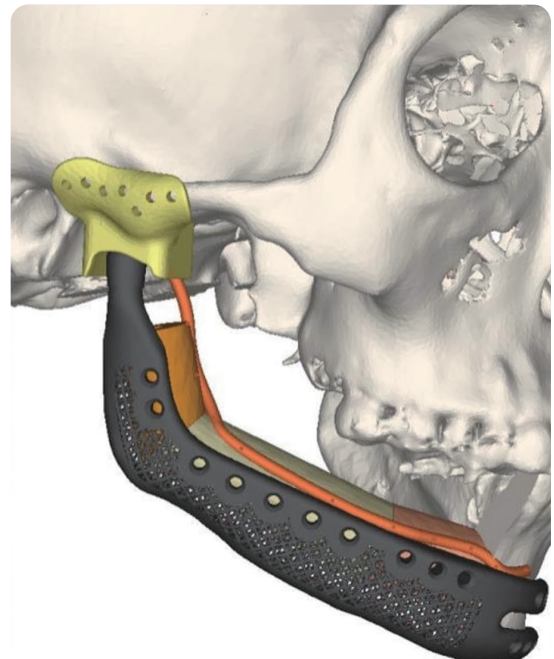
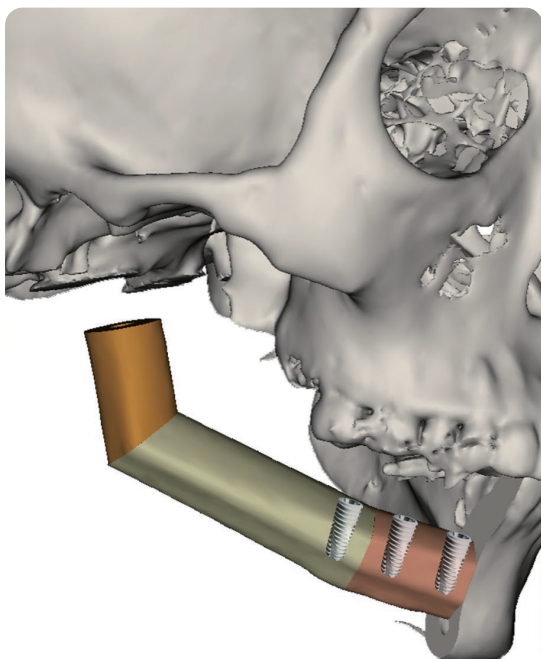

Surgical Procedure

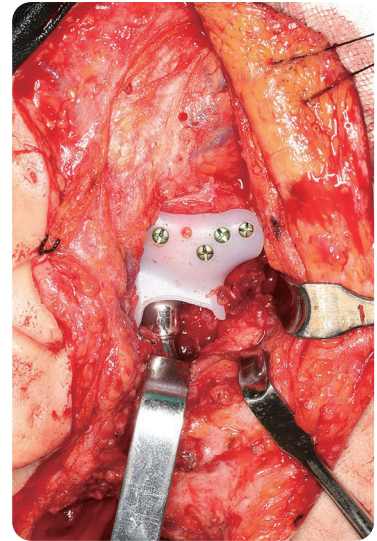
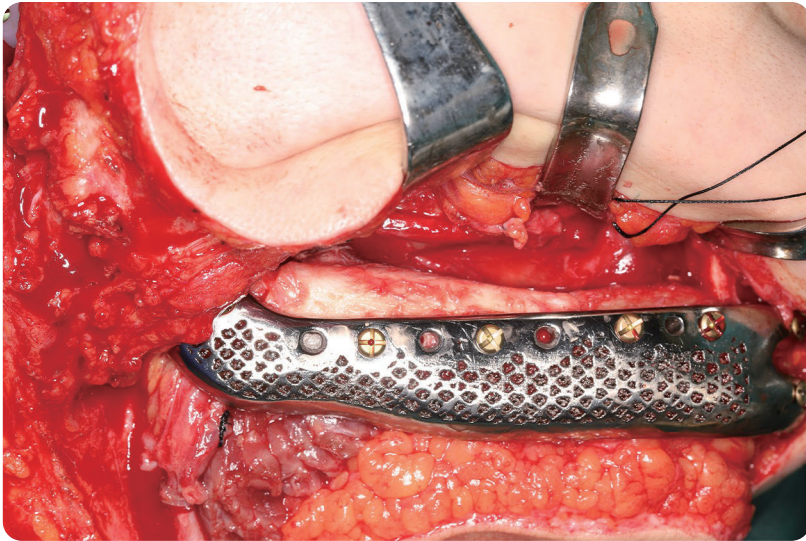

Surgical Outcome

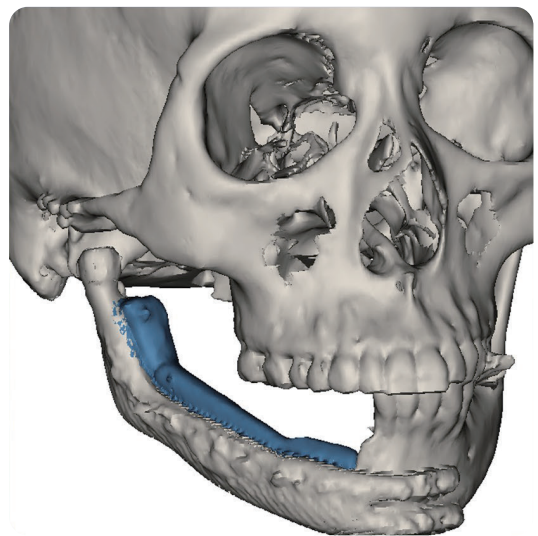
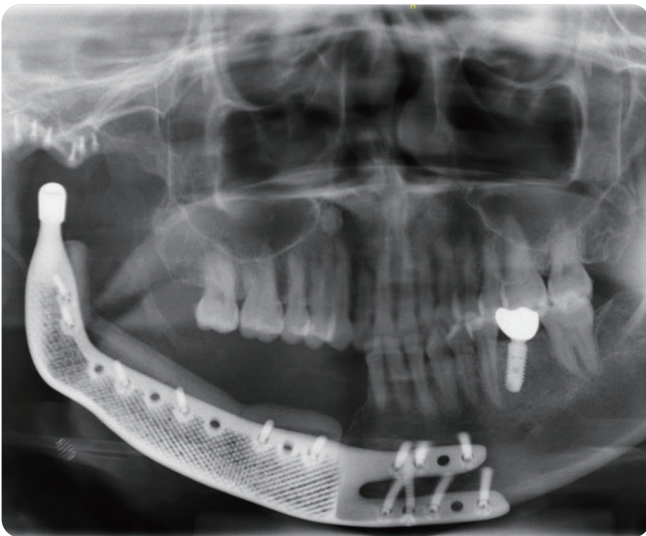

Standard Total TMJ Prosthesis

Standard TMJ Prosthesis

Model	l/mm	h/mm
GFGJL26H45	26	45
GFGJL26H50	26	50
GFGJL26H55	26	55

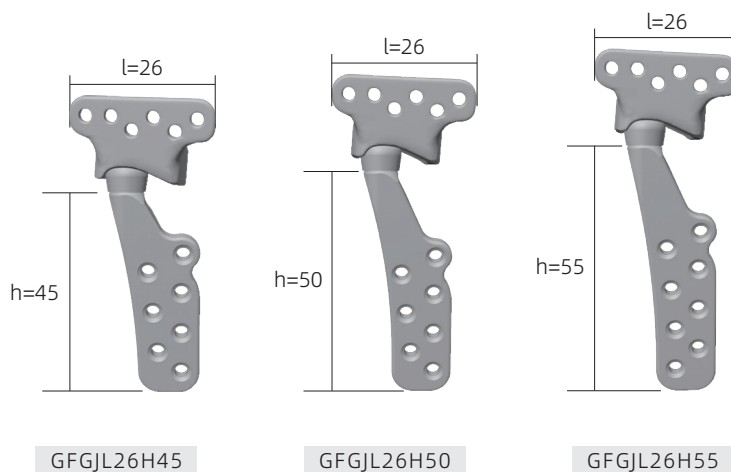

Standard TMJ Prosthesis

Model	l/mm	h/mm
GFGJL30H45	30	45
GFGJL30H50	30	50
GFGJL30H55	30	55

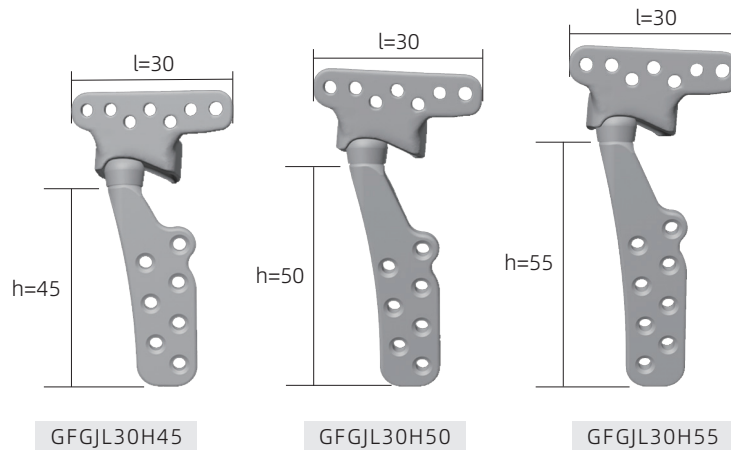

Bone Screw, Cross-Head

Model	d ₁ /mm	l/mm
2.0 MP Self-tapping screw	2.0	3~20 (1 mm increments per specification)
2.1 MP Self-tapping screw	2.1	
2.4 MP Self-tapping screw	2.4	
2.7 MP Self-tapping screw	2.7	
2.9 MP Self-tapping screw	2.9	

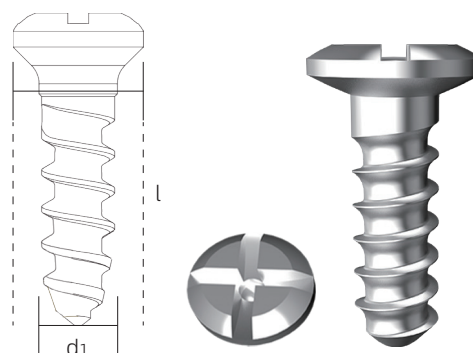



Gaofeng Medical WeChat Official Account